



**FEATURES**

- High energy and very high capacitance design
- All tantalum sealed case
- Termination: radial leaded
- 100% accelerated steady state aging
- 100% temperature stability
- 100% barometric pressure
- Voltage rating of 10-150V
- Operating temperature rang of -55°C to +125°C

**APPLICATIONS**

Typical applications include energy storage and power compensation.

**ORDERING INFORMATION**

CAK36	-50V	-1000μF	-M	-CD1	-A
Series	Rated voltage	Capacitance	Capacitance tolerance	Case size	Mounting Form
Tantalum Solid Electrolytic Chip Capacitors For High Reliability	10V 16V 25V 35V 50V 63V 80V 100V 125V 150V	Refer to Capacitance and Rated Voltage Range	K=±10% M=±20%	Refer to Dimensions and Mounting Form	Refer to Dimensions and Mounting Form

**DIMENSIONS**

Unit:mm

Case Size	Cylindrical Case					Mounting Form
	D±0.50	H±0.50	L1min	L2±0.76	D1±0.38	
CA1	Φ12	8.00	7	5.84	4	A、B、C、C1
CA2		10.00				
CA3		12.00				
CB1	Φ16	8.00	7	5.84	5.08	A(A1、A2)、 B、C、C1
CB2		10.00				
CB3		12.00				
CB4		16.00				
CC1	Φ19	8.00	7	5.84	6	A、B、C、 C1、BL、CL
CC2		10.00				
CC3		12.00				
CC4		16.00				
CC5		18.00				
CC6		20.00				
CD1	Φ22	8.00	7	5.84	7.50	A(A1、A2)、 B、C、C1、 BL、CL
CD2		10.00				
CD3		12.00				
CD4		16.00				
CD5		18.00				
CD6		20.00				
CE1	Φ35.5	8.00	7	5.84	10.16	A(A1、A2、 A3)、B、C、 BL、CL
CE2		10.00				
CE3		12.00				
CE4		16.00				
CE5		18.00				
CE6		20.00				
CE7		24.00				

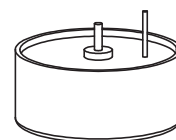
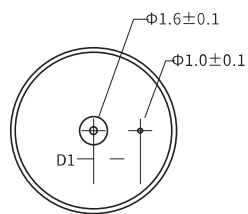
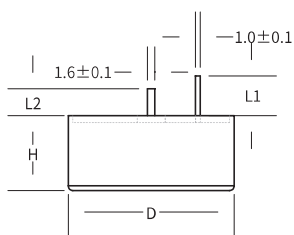

Mounting Form A

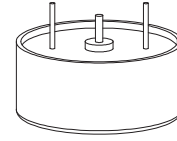
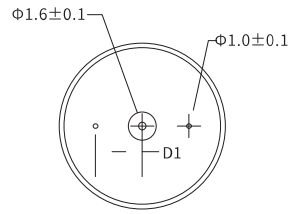
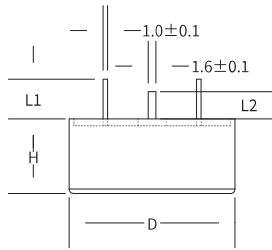

Mounting Form B

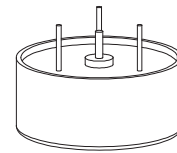
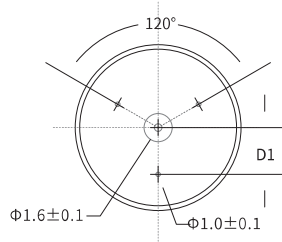
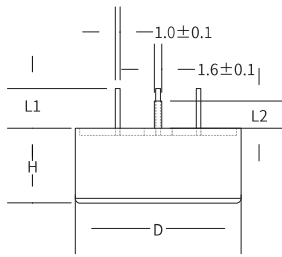

Mounting Form C

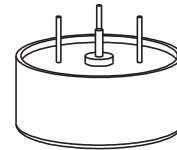
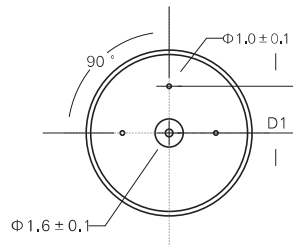
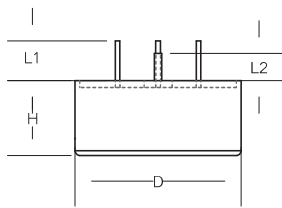

Mounting Form C1

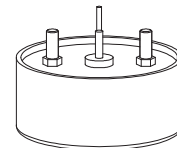
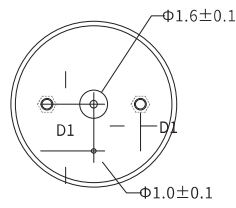
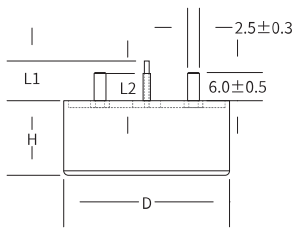

Mounting Form BL

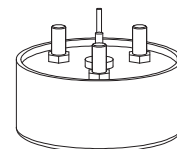
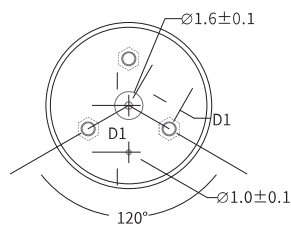
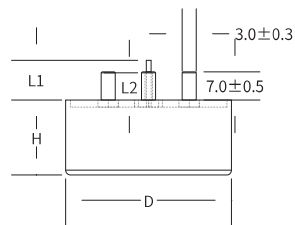

Mounting Form CL

**DIMENSIONS**

Unit:mm

Case Size	Flange Case					Mounting Form
	D±0.50	H±0.50	L1min	L2±0.76	D1±0.38	
FE1	Φ35.5	8.00	7	5.84	10.16	D、E
FE2		10.00				
FE3		12.00				
FE4		16.00				
FE5		18.00				
FE6		20.00				
FE7		24.00				

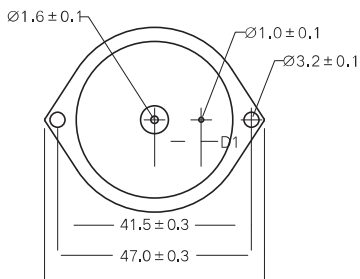
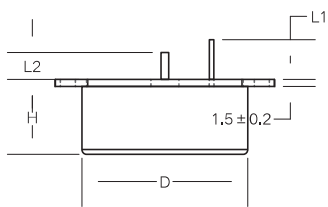

Mounting Form D

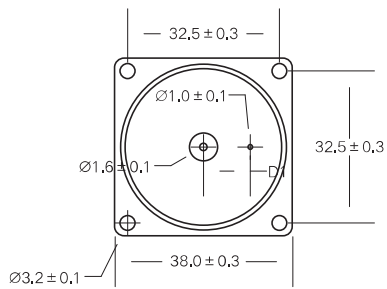
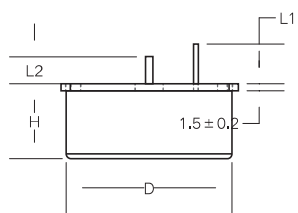
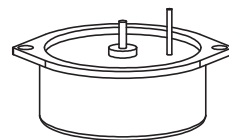

Mounting Form E

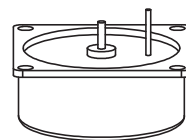

**DIMENSIONS**

Unit:mm

Square Case						Mounting Form
Case Size	D±0.50	H±0.50	L1min	L2±0.76	D1±0.38	
SB1	16.00	8.00	7.00	5.84	5.00	F(F1)、F3
SB2		10.00				
SB3		12.00				
SB4		16.00				
SC1	20.00	8.00	7.00	5.84	6.00	F(F1)、F3、G
SC2		10.00				
SC3		12.00				
SC4		16.00				
SC5		18.00				
SC6		20.00				
SE1	35.50	8.00	7.00	5.84	10.16	F(F1)、F3、F4、G
SE2		10.00				
SE3		12.00				
SE4		16.00				
SE5		18.00				
SE6		20.00				
SE7		24.00				

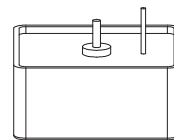
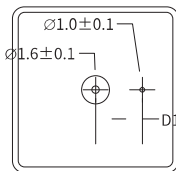
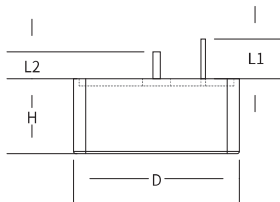

Mounting Form F

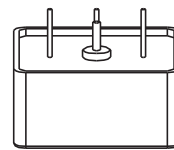
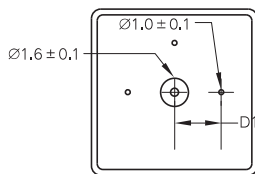
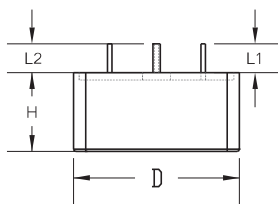

Mounting Form F3

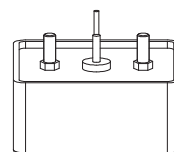
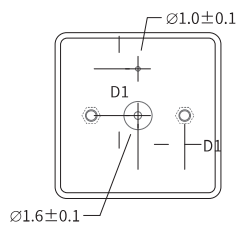
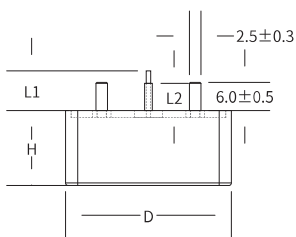

Mounting Form G

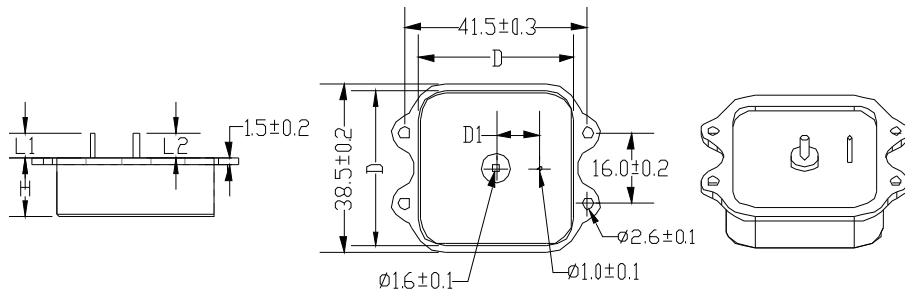

Mounting Form F4

Mounting Bracket

Unit:mm

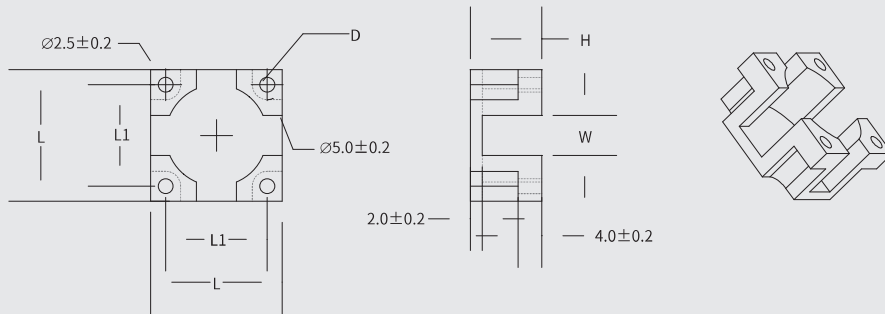

Mounting Form A1

Size	$D \pm 0.2$	$L \pm 0.2$	$L_1 \pm 0.2$	$H \pm 0.2$	$W \pm 0.2$
$\phi 16$	16.5	22	17	8/12/16	6.7
$\phi 22$	22.5	28	23	8/12/16	9
$\phi 35.5$	36.5	37	32	8/12/16	11.3

Unit:mm

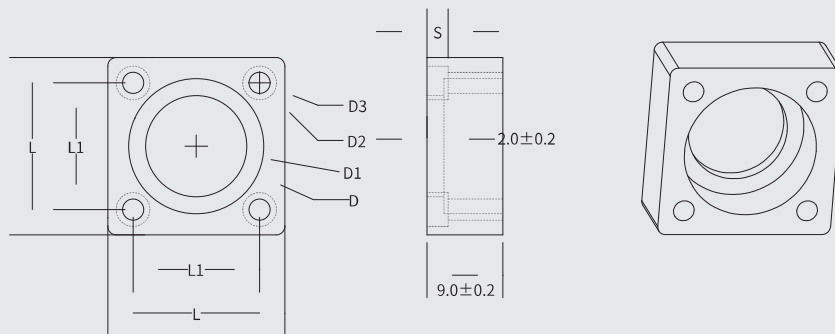

Mounting Form A2

Size	$D \pm 0.2$	$L \pm 0.2$	$L_1 \pm 0.2$	$D_1 \pm 0.2$	$D_2 \pm 0.2$	$D_3 \pm 0.2$	$S \pm 0.2$
$\phi 16$	16.5	21	15	12	4.5	2.5	2.5
$\phi 22$	22.5	28	21	18	5.5	3	3
$\phi 35.5$	36.5	40	32	32	7	4	4

Unit:mm

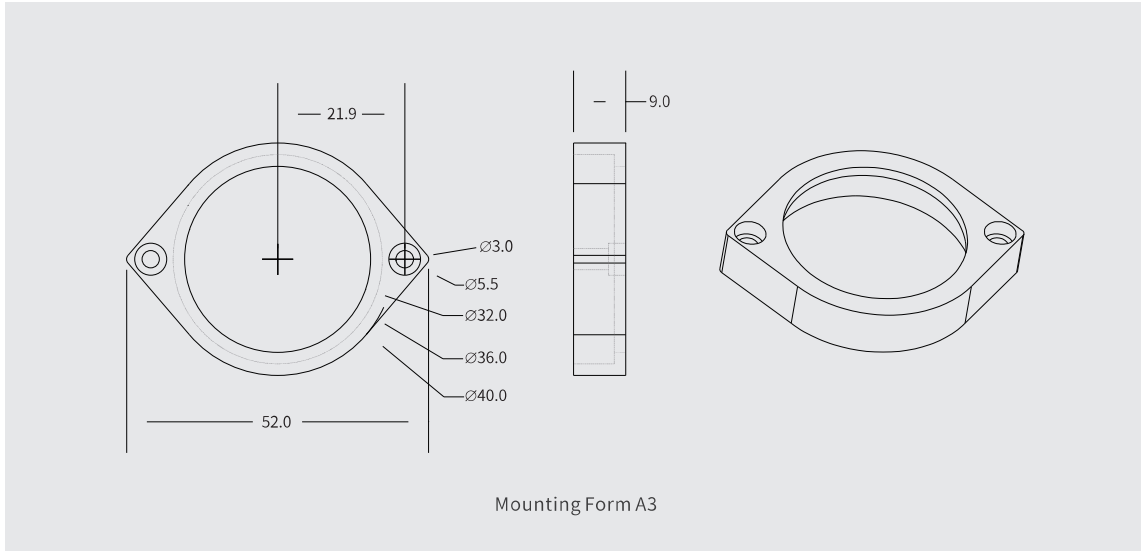

Unit:mm

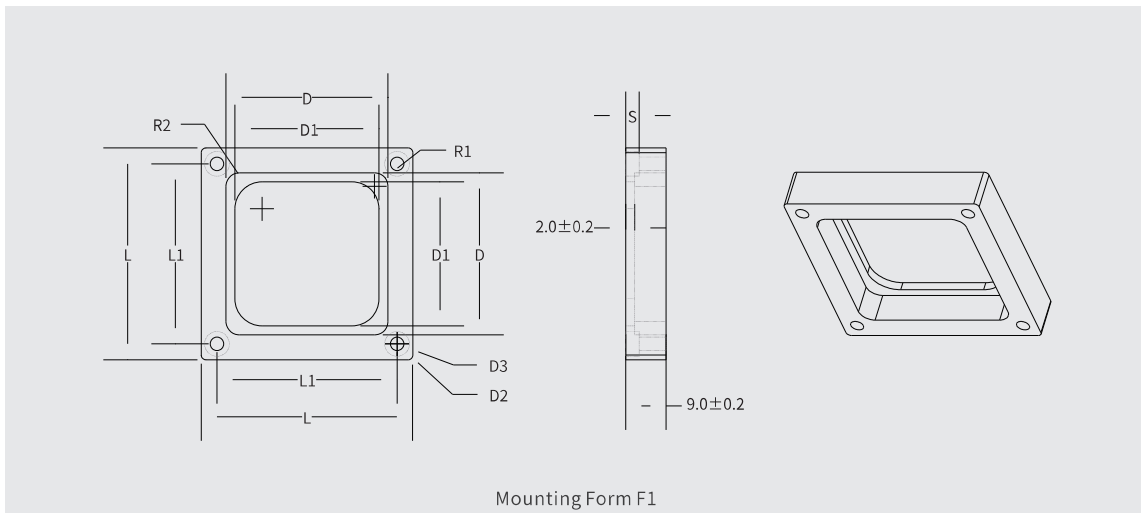

Size	D±0.2	L±0.2	L1±0.2	D1±0.2	D2±0.2	D3±0.2	R1±0.2	R2±0.2	S±0.2
20×20	20.5	30	24	16	5.5	3	2	4	2
35.5×35.5	36.5	47	39	32	7	4	4	6	3

**CAPACITANCE AND RATED VOLTAGE RANGE**

Size	Size Code	Rated Cap (μF)	Maximum Value									Product Weight* (g)
			Tgδ(%)	ESR(Ω) 1kHz	Max DCL(μA)			Max Impedance (Ω) at -55°C 100Hz	Max Cap Deviation(%)			
					25°C	85°C	125°C		-55°C	85°C	125°C	
Rated voltage@85°C:10V Category Voltage@125°C:6V Surge Voltage:11V												
φ 12×8	CA1	4000	120	0.600	32	256	320	20.0	-75	85	100	7
φ 12×10	CA2	4800	120	0.600	35	280	350	10.0	-75	85	100	8
φ 12×12	CA3	8000	120	0.400	60	480	600	10.0	-75	85	100	10
φ 16×8	CB1	8000	120	0.200	60	480	600	5.0	-75	85	100	12
φ 16×10	CB2	11000	120	0.200	85	680	850	4.0	-75	85	100	14
φ 16×12	CB3	15000	120	0.200	120	960	1200	3.6	-75	85	100	17
φ 16×16	CB4	22000	120	0.100	180	1440	1800	3.0	-75	85	100	22
φ 22×8	CD1	15000	130	0.100	120	960	1200	8.0	-80	85	100	23
φ 22×10	CD2	22000	130	0.100	180	1440	1800	6.0	-80	85	100	28
φ 22×12	CD3	30000	130	0.100	200	1600	2000	2.4	-80	85	100	33
φ 22×16	CD4	45000	130	0.100	200	1600	2000	1.0	-80	85	100	45
φ 22×18	CD5	50000	130	0.100	200	1600	2000	1.0	-80	85	100	52
φ 22×20	CD6	60000	130	0.100	300	2400	3000	1.0	-80	85	100	60
φ 35.5×8	CE1	50000	180	0.050	200	1600	2000	1.0	-80	85	100	52
φ 35.5×10	CE2	70000	180	0.050	300	2400	3000	1.0	-80	85	100	68
φ 35.5×12	CE3	100000	180	0.035	300	2400	3000	1.0	-80	85	100	80
φ 35.5×16	CE4	150000	180	0.025	300	2400	3000	1.0	-80	85	100	100
φ 35.5×18	CE5	175000	190	0.025	300	2400	3000	1.0	-80	85	100	120
φ 35.5×20	CE6	200000	190	0.025	400	3200	4000	1.0	-80	85	100	140
φ 35.5×24	CE7	250000	190	0.025	400	3200	4000	1.0	-80	85	100	160
φ 35.5×8	FE1	50000	180	0.050	200	1600	2000	1.0	-80	85	100	65
φ 35.5×10	FE2	70000	180	0.050	300	2400	3000	1.0	-80	85	100	80
φ 35.5×12	FE3	100000	180	0.035	300	2400	3000	1.0	-80	85	100	90
φ 35.5×16	FE4	150000	180	0.025	300	2400	3000	1.0	-80	85	100	115
φ 35.5×18	FE5	175000	190	0.025	300	2400	3000	1.0	-80	85	100	135
φ 35.5×20	FE6	200000	190	0.025	400	3200	4000	1.0	-80	85	100	160
φ 35.5×24	FE7	250000	190	0.025	400	3200	4000	1.0	-80	85	100	180
20×20×8	SC1	20000	130	0.200	120	960	1200	8.0	-80	85	100	23
20×20×10	SC2	26000	130	0.120	180	1440	1800	6.0	-80	85	100	28
20×20×12	SC3	40000	130	0.100	200	1600	2000	4.0	-80	85	100	35
20×20×16	SC4	60000	130	0.070	300	2400	3000	1.0	-80	85	100	45
20×20×18	SC5	72000	130	0.070	300	2400	3000	2.7	-80	85	100	50
20×20×20	SC6	80000	130	0.050	300	2400	3000	2.0	-80	85	100	55
35.5×35.5×8	SE1	60000	180	0.050	300	2400	3000	1.0	-80	85	100	65
35.5×35.5×10	SE2	80000	180	0.050	300	2400	3000	1.0	-80	85	100	85
35.5×35.5×12	SE3	120000	180	0.040	400	3200	4000	1.0	-80	85	100	90
35.5×35.5×16	SE4	180000	180	0.025	400	3200	4000	1.0	-80	85	100	123
35.5×35.5×18	SE5	220000	190	0.025	400	3200	4000	1.0	-80	85	100	145
35.5×35.5×20	SE6	240000	190	0.025	600	4800	6000	1.0	-80	85	100	148
35.5×35.5×24	SE7	300000	190	0.025	700	5600	7000	1.0	-80	85	100	185



**CAPACITANCE AND RATED VOLTAGE RANGE**

Size	Size Code	Rated Cap (μF)	Maximum Value									Product Weight* (g)
			Tgδ(%)	ESR(Ω) 1kHz	Max DCL(μA)			Max Impedance (Ω) at -55°C 100Hz	Max Cap Deviation(%)			
					25°C	85°C	125°C		-55°C	85°C	125°C	
Rated voltage@85°C:16V Category Voltage@125°C:9.6V Surge Voltage:17.6V												
φ 12×8	CA1	2000	100	0.600	25	200	250	20.0	-70	85	100	7
φ 12×10	CA2	2400	100	0.600	30	240	300	10.0	-70	85	100	8
φ 12×12	CA3	4000	100	0.400	50	400	500	10.0	-70	85	100	10
φ 16×8	CB1	5000	100	0.200	60	480	600	5.0	-70	85	100	12
φ 16×10	CB2	7000	100	0.200	90	720	900	4.0	-70	85	100	14
φ 16×12	CB3	9000	100	0.200	110	880	1100	3.6	-70	85	100	17
φ 16×16	CB4	13500	100	0.100	170	1360	1700	3.0	-70	85	100	22
φ 22×8	CD1	9000	110	0.250	130	1040	1300	8.0	-80	85	100	23
φ 22×10	CD2	12000	110	0.100	150	1200	1500	6.0	-80	85	100	28
φ 22×12	CD3	18000	110	0.100	200	1600	2000	2.4	-80	85	100	33
φ 22×16	CD4	27000	110	0.100	300	2400	3000	1.0	-80	85	100	45
φ 22×18	CD5	35000	110	0.100	350	2800	3500	1.0	-80	85	100	52
φ 22×20	CD6	36000	110	0.100	400	3200	4000	1.0	-80	85	100	60
φ 35.5×8	CE1	30000	160	0.050	150	1200	1500	1.0	-80	85	100	52
φ 35.5×10	CE2	40000	160	0.050	200	1600	2000	1.0	-80	85	100	68
φ 35.5×12	CE3	60000	165	0.035	300	2400	3000	1.0	-80	85	100	80
φ 35.5×16	CE4	90000	165	0.025	300	2400	3000	1.0	-80	85	100	100
φ 35.5×18	CE5	100000	170	0.025	400	3200	4000	1.0	-80	85	100	120
φ 35.5×20	CE6	120000	170	0.025	400	3200	4000	1.0	-80	85	100	140
φ 35.5×24	CE7	150000	170	0.025	600	4800	6000	1.0	-80	85	100	160
φ 35.5×8	FE1	30000	160	0.050	150	1200	1500	1.0	-80	85	100	65
φ 35.5×10	FE2	40000	160	0.050	200	1600	2000	1.0	-80	85	100	80
φ 35.5×12	FE3	60000	165	0.035	300	2400	3000	1.0	-80	85	100	90
φ 35.5×16	FE4	90000	165	0.025	300	2400	3000	1.0	-80	85	100	115
φ 35.5×18	FE5	100000	170	0.025	400	3200	4000	1.0	-80	85	100	135
φ 35.5×20	FE6	120000	170	0.025	400	3200	4000	1.0	-80	85	100	160
φ 35.5×24	FE7	150000	170	0.025	600	4800	6000	1.0	-80	85	100	180
20×20×8	SC1	11000	110	0.250	150	1200	1500	8.0	-80	85	100	23
20×20×10	SC2	14300	110	0.120	190	1520	1900	6.0	-80	85	100	28
20×20×12	SC3	22000	110	0.100	190	1520	1900	4.0	-80	85	100	35
20×20×16	SC4	33000	110	0.070	190	1520	1900	1.0	-80	85	100	45
20×20×18	SC5	42900	110	0.070	200	1600	2000	2.7	-80	85	100	50
20×20×20	SC6	44000	110	0.050	300	2400	3000	2.0	-80	85	100	55
35.5×35.5×8	SE1	45000	160	0.050	300	2400	3000	1.0	-80	85	100	65
35.5×35.5×10	SE2	60000	160	0.050	300	2400	3000	1.0	-80	85	100	85
35.5×35.5×12	SE3	90000	165	0.040	400	3200	4000	1.0	-80	85	100	90
35.5×35.5×16	SE4	130000	165	0.025	400	3200	4000	1.0	-80	85	100	123
35.5×35.5×18	SE5	150000	165	0.025	400	3200	4000	1.0	-80	85	100	145
35.5×35.5×20	SE6	160000	165	0.025	500	4000	5000	1.0	-80	85	100	148
35.5×35.5×24	SE7	200000	165	0.025	800	6400	8000	1.0	-80	85	100	185

**CAPACITANCE AND RATED VOLTAGE RANGE**

Size	Size Code	Rated Cap (μF)	Maximum Value									Product Weight* (g)
			Tgδ(%)	ESR(Ω) 1kHz	Max DCL(μA)			Max Impedance (Ω) at -55°C 100Hz	Max Cap Deviation(%)			
					25°C	85°C	125°C		-55°C	85°C	125°C	
Rated voltage@85°C:25V Category Voltage@125°C:15V Surge Voltage:27.5V												
φ12×8	CA1	1500	70	0.600	30	240	300	20.0	-60	80	100	7
φ12×10	CA2	1800	70	0.600	36	288	360	12.0	-60	80	100	8
φ12×12	CA3	3000	70	0.400	60	480	600	10.0	-60	80	100	10
φ16×8	CB1	3000	70	0.200	60	480	600	5.0	-60	80	100	12
φ16×10	CB2	4200	70	0.200	84	672	840	4.0	-60	80	100	14
φ16×12	CB3	6000	70	0.200	120	960	1200	3.6	-60	80	100	17
φ16×16	CB4	9000	70	0.100	180	1440	1800	3.0	-60	80	100	22
φ22×8	CD1	6000	70	0.250	120	960	1200	8.0	-75	80	100	23
φ22×10	CD2	8600	70	0.100	180	1440	1800	6.0	-75	80	100	28
φ22×12	CD3	12000	70	0.100	240	1920	2400	2.4	-75	80	100	33
φ22×16	CD4	18000	70	0.100	360	2880	3600	1.0	-75	80	100	45
φ22×18	CD5	22000	70	0.100	440	3520	4400	1.0	-75	80	100	52
φ22×20	CD6	24000	70	0.100	480	3840	4800	1.0	-75	80	100	60
φ35.5×8	CE1	18000	120	0.050	150	1200	1500	1.0	-75	80	100	52
φ35.5×10	CE2	25000	120	0.050	200	1600	2000	1.0	-75	80	100	68
φ35.5×12	CE3	36000	130	0.040	300	2400	3000	1.0	-75	80	100	80
φ35.5×16	CE4	54000	130	0.035	350	2800	3500	1.0	-75	80	100	100
φ35.5×18	CE5	70000	140	0.025	400	3200	4000	1.0	-75	80	100	120
φ35.5×20	CE6	70000	140	0.025	400	3200	4000	1.0	-75	80	100	140
φ35.5×24	CE7	90000	140	0.025	500	4000	5000	1.0	-75	80	100	160
φ35.5×8	FE1	18000	120	0.050	150	1200	1500	1.0	-75	80	100	65
φ35.5×10	FE2	25000	120	0.050	200	1600	2000	1.0	-75	80	100	80
φ35.5×12	FE3	36000	130	0.040	300	2400	3000	1.0	-75	80	100	90
φ35.5×16	FE4	54000	130	0.035	350	2800	3500	1.0	-75	80	100	115
φ35.5×18	FE5	70000	140	0.025	400	3200	4000	1.0	-75	80	100	135
φ35.5×20	FE6	70000	140	0.025	400	3200	4000	1.0	-75	80	100	160
φ35.5×24	FE7	90000	140	0.025	500	4000	5000	1.0	-75	80	100	180
20×20×8	SC1	6700	85	0.250	125	1000	1250	8.0	-75	80	100	23
20×20×10	SC2	8700	85	0.120	180	1440	1800	6.0	-75	80	100	28
20×20×12	SC3	13400	85	0.100	268	2144	2680	4.0	-75	80	100	35
20×20×16	SC4	20100	85	0.070	400	3200	4000	1.0	-75	80	100	45
20×20×18	SC5	26000	85	0.070	500	4000	5000	2.7	-75	80	100	50
20×20×20	SC6	26800	85	0.050	500	4000	5000	2.0	-75	80	100	55
35.5×35.5×8	SE1	25000	120	0.050	200	1600	2000	1.0	-75	80	100	65
35.5×35.5×10	SE2	35000	120	0.050	300	2400	3000	1.0	-75	80	100	85
35.5×35.5×12	SE3	50000	130	0.045	400	3200	4000	1.0	-75	80	100	90
35.5×35.5×16	SE4	75000	130	0.035	400	3200	4000	1.0	-75	80	100	123
35.5×35.5×18	SE5	85000	130	0.035	500	4000	5000	1.0	-75	80	100	145
35.5×35.5×20	SE6	100000	140	0.030	500	4000	5000	1.0	-75	80	100	148
35.5×35.5×24	SE7	125000	140	0.030	700	5600	7000	1.0	-75	80	100	185

**CAPACITANCE AND RATED VOLTAGE RANGE**

Size	Size Code	Rated Cap (μF)	Maximum Value									Product Weight* (g)
			Tgδ(%)	ESR(Ω) 1kHz	Max DCL(μA)			Max Impedance (Ω) at -55°C 100Hz	Max Cap Deviation(%)			
					25°C	85°C	125°C		-55°C	85°C	125°C	
<b>Rated voltage@85°C:35V Category Voltage@125°C:20V Surge Voltage:38.5V</b>												
φ12×8	CA1	1000	50	0.600	28	224	280	20.0	-60	80	100	7
φ12×10	CA2	1200	50	0.600	33	264	330	12.0	-60	80	100	8
φ12×12	CA3	2000	50	0.400	56	448	560	10.0	-60	80	100	10
φ16×8	CB1	2500	50	0.200	70	560	700	5.0	-60	80	100	12
φ16×10	CB2	3500	50	0.200	98	784	980	4.0	-60	80	100	14
φ16×12	CB3	4600	50	0.200	130	1040	1300	4.0	-60	80	100	17
φ16×16	CB4	7000	50	0.100	200	1600	2000	3.0	-60	80	100	22
φ22×8	CD1	5200	55	0.250	150	1200	1500	8.0	-70	80	100	23
φ22×10	CD2	6600	55	0.120	200	1600	2000	6.0	-70	80	100	28
φ22×12	CD3	10400	55	0.100	290	2320	2900	2.4	-70	80	100	33
φ22×16	CD4	15600	55	0.100	200	1600	2000	1.0	-70	80	100	45
φ22×18	CD5	18000	55	0.100	200	1600	2000	1.0	-70	80	100	52
φ22×20	CD6	20800	55	0.100	300	2400	3000	1.0	-70	80	100	60
φ35.5×8	CE1	12000	90	0.065	150	1200	1500	1.0	-70	75	100	52
φ35.5×10	CE2	16000	90	0.065	200	1600	2000	1.2	-70	75	100	68
φ35.5×12	CE3	24000	95	0.040	300	2400	3000	1.0	-70	75	100	80
φ35.5×16	CE4	36000	95	0.035	300	2400	3000	1.0	-70	75	100	100
φ35.5×18	CE5	40000	100	0.025	400	3200	4000	1.0	-70	75	100	120
φ35.5×20	CE6	50000	100	0.025	400	3200	4000	1.0	-70	75	100	140
φ35.5×24	CE7	60000	100	0.025	500	4000	5000	1.0	-70	75	100	160
φ35.5×8	FE1	12000	90	0.065	150	1200	1500	2.0	-70	75	100	65
φ35.5×10	FE2	16000	90	0.065	200	1600	2000	1.2	-70	75	100	80
φ35.5×12	FE3	24000	95	0.040	300	2400	3000	1.0	-70	75	100	90
φ35.5×16	FE4	36000	95	0.035	300	2400	3000	1.0	-70	75	100	115
φ35.5×18	FE5	40000	100	0.025	400	3200	4000	1.0	-70	75	100	135
φ35.5×20	FE6	50000	100	0.025	400	3200	4000	1.0	-70	75	100	160
φ35.5×24	FE7	60000	100	0.025	500	4000	5000	1.0	-70	75	100	180
20×20×8	SC1	4500	55	0.250	120	960	1200	8.0	-70	80	100	23
20×20×10	SC2	5800	55	0.120	170	1360	1700	6.0	-70	80	100	28
20×20×12	SC3	9000	55	0.100	250	2000	2500	4.0	-70	80	100	35
20×20×16	SC4	13500	55	0.070	380	3040	3800	1.0	-70	80	100	45
20×20×18	SC5	15000	55	0.070	500	4000	5000	2.7	-70	80	100	50
20×20×20	SC6	18000	55	0.050	500	4000	5000	2.0	-70	80	100	55
35.5×35.5×8	SE1	16000	90	0.065	200	1600	2000	1.0	-70	80	100	65
35.5×35.5×10	SE2	22000	95	0.070	300	2400	3000	1.0	-70	80	100	85
35.5×35.5×12	SE3	33000	95	0.050	300	2400	3000	1.0	-70	80	100	90
35.5×35.5×16	SE4	50000	95	0.035	400	3200	4000	1.0	-70	80	100	123
35.5×35.5×18	SE5	58000	95	0.035	400	3200	4000	1.0	-70	80	100	145
35.5×35.5×20	SE6	65000	100	0.030	400	3200	4000	1.0	-70	80	100	148
35.5×35.5×24	SE7	75000	100	0.030	700	5600	7000	1.0	-70	80	100	185

**CAPACITANCE AND RATED VOLTAGE RANGE**

Size	Size Code	Rated Cap (μF)	Maximum Value									Product Weight* (g)
			Tgδ(%)	ESR(Ω) 1kHz	Max DCL(μA)			Max Impedance (Ω) at -55°C 100Hz	Max Cap Deviation(%)			
					25°C	85°C	125°C		-55°C	85°C	125°C	
Rated voltage@85°C:50V Category Voltage@125°C:30V Surge Voltage:55V												
φ12×8	CA1	700	40	0.600	25	200	250	13.0	-45	70	100	7
φ12×8	CA1	840	40	0.600	30	240	300	13.0	-45	70	100	7
φ12×10	CA2	840	40	0.600	30	240	300	13.0	-45	70	100	8
φ12×12	CA3	1400	40	0.400	55	440	550	10.0	-45	70	100	10
φ16×8	CB1	1400	40	0.250	50	400	500	5.2	-45	70	100	12
φ16×8	CB1	1500	40	0.250	50	400	500	5.2	-45	70	100	12
φ16×10	CB2	2000	40	0.250	60	480	600	4.0	-55	70	100	14
φ16×12	CB3	2800	40	0.200	100	800	1000	4.0	-55	70	100	17
φ16×12	CB3	3400	45	0.200	130	1040	1300	4.0	-60	70	100	17
φ16×16	CB4	4200	40	0.100	150	1200	1500	2.1	-55	70	100	22
φ22×8	CD1	2500	45	0.300	80	640	800	9.6	-60	70	100	23
φ22×8	CD1	3000	45	0.300	100	800	1000	9.6	-60	70	100	23
φ22×10	CD2	4200	45	0.120	100	800	1000	6.0	-65	70	100	28
φ22×12	CD3	6000	45	0.100	170	1360	1700	1.2	-60	70	100	33
φ22×12	CD3	6800	45	0.100	170	1360	1700	1.2	-60	70	100	33
φ22×16	CD4	9000	45	0.100	350	2800	3500	1.0	-60	70	100	45
φ22×18	CD5	11000	50	0.100	400	3200	4000	1.0	-65	70	100	52
φ22×20	CD6	12000	55	0.100	450	3600	4500	1.0	-60	70	100	60
φ35.5×8	CE1	8000	65	0.070	140	1120	1400	1.2	-60	70	100	52
φ35.5×8	CE1	10000	65	0.070	200	1600	2000	1.2	-75	70	100	52
φ35.5×10	CE2	11000	65	0.070	250	2000	2500	1.2	-60	70	100	68
φ35.5×12	CE3	16000	65	0.040	250	2000	2500	1.2	-55	70	100	80
φ35.5×12	CE3	18000	65	0.040	400	3200	4000	1.5	-55	70	100	80
φ35.5×16	CE4	16000	70	0.045	400	3200	4000	2.5	-45	70	100	100
φ35.5×16	CE4	24000	70	0.035	350	2800	3500	1.2	-55	70	100	100
φ35.5×18	CE5	30000	75	0.025	400	3200	4000	1.2	-60	70	100	120
φ35.5×20	CE6	32000	75	0.025	500	4000	5000	1.2	-60	70	100	140
φ35.5×24	CE7	40000	75	0.025	600	4800	6000	1.2	-60	70	100	160
φ35.5×8	FE1	8000	65	0.070	140	1120	1400	1.2	-60	70	100	65
φ35.5×10	FE2	11000	65	0.070	250	2000	2500	1.2	-60	70	100	80
φ35.5×12	FE3	16000	70	0.040	250	2000	2500	1.2	-55	70	100	90
φ35.5×16	FE4	24000	70	0.035	350	2800	3500	1.2	-55	70	100	115
φ35.5×18	FE5	30000	75	0.025	400	3200	4000	1.2	-60	70	100	135
φ35.5×20	FE6	32000	75	0.025	500	4000	5000	1.2	-60	70	100	160
φ35.5×24	FE7	40000	75	0.025	600	4800	6000	1.2	-60	70	100	180
16×16×8	SB1	2200	50	0.350	80	640	800	10.0	-70	70	100	15
16×16×10	SB2	3600	50	0.300	100	800	1000	8.0	-70	70	100	17
16×16×12	SB3	4500	50	0.300	170	1360	1700	5.0	-70	70	100	20
16×16×16	SB4	6600	50	0.250	240	1920	2400	4.0	-70	70	100	25
20×20×8	SC1	3500	60	0.300	120	960	1200	8.0	-60	70	100	23

**CAPACITANCE AND RATED VOLTAGE RANGE**

Size	Size Code	Rated Cap (μF)	Maximum Value									Product Weight* (g)
			Tgδ(%)	ESR(Ω) 1kHz	Max DCL(μA)			Max Impedance (Ω) at -55°C 100Hz	Max Cap Deviation(%)			
					25°C	85°C	125°C		-55°C	85°C	125°C	
20×20×10	SC2	4500	60	0.150	150	1200	1500	6.0	-65	70	100	28
20×20×12	SC3	7000	60	0.130	250	2000	2500	4.0	-60	70	100	35
20×20×16	SC4	10000	60	0.100	400	3200	4000	2.7	-60	70	100	45
20×20×18	SC5	12000	60	0.080	500	4000	5000	2.7	-60	70	100	50
20×20×20	SC6	14000	70	0.060	500	4000	5000	2.0	-65	70	100	55
35.5×35.5×8	SE1	10000	65	0.070	200	1600	2000	1.2	-60	70	100	65
35.5×35.5×10	SE2	15000	70	0.070	300	2400	3000	1.2	-60	70	100	85
35.5×35.5×12	SE3	20000	75	0.050	350	2800	3500	1.2	-60	70	100	90
35.5×35.5×16	SE4	30000	75	0.035	450	3600	4500	1.2	-55	70	100	123
35.5×35.5×18	SE5	35000	75	0.035	450	3600	4500	1.2	-55	70	100	145
35.5×35.5×20	SE6	40000	75	0.030	500	4000	5000	1.2	-65	70	100	148
35.5×35.5×24	SE7	45000	80	0.030	650	5200	6500	1.0	-70	70	100	185

**CAPACITANCE AND RATED VOLTAGE RANGE**

Size	Size Code	Rated Cap (μF)	Maximum Value									Product Weight* (g)
			Tgδ(%)	ESR(Ω) 1kHz	Max DCL(μA)			Max Impedance (Ω) at -55°C 100Hz	Max Cap Deviation(%)			
					25°C	85°C	125°C		-55°C	85°C	125°C	
Rated voltage@85°C:63V Category Voltage@125°C:38V Surge Voltage:69.3V												
φ12×8	CA1	500	30	0.550	25	200	250	10.0	-40	70	100	8
φ12×10	CA2	600	30	0.500	30	240	300	10.0	-45	70	100	9
φ12×12	CA3	1000	30	0.450	50	400	500	8.0	-40	70	100	11
φ16×8	CB1	600	30	0.350	30	240	300	8.2	-40	70	100	12
φ16×8	CB1	1000	30	0.300	50	400	500	8.0	-40	70	100	12
φ16×10	CB2	800	30	0.290	40	320	400	8.0	-40	70	100	15
φ16×12	CB3	1800	30	0.250	90	720	900	4.2	-40	70	100	18
φ16×16	CB4	2200	40	0.150	110	880	1100	8.0	-40	70	100	25
φ22×8	CD1	1200	35	0.180	65	520	650	6.0	-40	70	100	25
φ22×10	CD2	1800	35	0.150	90	720	900	5.0	-50	70	100	30
φ22×12	CD3	2600	35	0.090	150	1200	1500	3.0	-40	70	100	33
φ22×16	CD4	3900	35	0.060	180	1440	1800	2.0	-40	70	100	50
φ22×18	CD5	4500	35	0.060	200	1600	2000	1.8	-40	70	100	55
φ22×20	CD6	5200	35	0.050	250	2000	2500	1.5	-40	70	100	65
φ35.5×8	CE1	4000	45	0.100	150	1200	1500	1.4	-40	70	100	52
φ35.5×10	CE2	5600	45	0.080	200	1600	2000	1.4	-40	70	100	72
φ35.5×12	CE3	8000	50	0.055	250	2000	2500	1.4	-45	70	100	80
φ35.5×16	CE4	12000	50	0.035	350	2800	3500	1.4	-45	70	100	110
φ35.5×18	CE5	16000	55	0.035	400	3200	4000	1.4	-40	70	100	120
φ35.5×20	CE6	16000	55	0.035	400	3200	4000	1.4	-40	70	100	140
φ35.5×24	CE7	20000	55	0.035	550	4400	5500	1.4	-40	70	100	165
φ35.5×8	FE1	4000	45	0.100	150	1200	1500	1.4	-40	70	100	68
φ35.5×10	FE2	5600	45	0.080	200	1600	2000	1.4	-40	70	100	85
φ35.5×12	FE3	8000	50	0.055	250	2000	2500	1.4	-45	70	100	90
φ35.5×16	FE4	12000	50	0.035	350	2800	3500	1.4	-45	70	100	115
φ35.5×18	FE5	16000	55	0.035	400	3200	4000	1.4	-40	70	100	135
φ35.5×20	FE6	16000	55	0.035	400	3200	4000	1.4	-40	70	100	160
φ35.5×24	FE7	20000	55	0.035	550	4400	5500	1.4	-40	70	100	180
20×20×8	SC1	2200	35	0.200	100	800	1000	3.0	-50	70	100	23
20×20×10	SC2	2800	35	0.150	150	1200	1500	3.0	-55	70	100	28
20×20×12	SC3	4400	35	0.150	200	1600	2000	1.8	-50	70	100	38
20×20×16	SC4	6600	35	0.100	300	2400	3000	1.5	-50	70	100	45
20×20×18	SC5	8800	35	0.100	350	2800	3500	1.5	-55	70	100	52
20×20×20	SC6	8800	35	0.080	350	2800	3500	1.5	-50	70	100	58
35.5×35.5×8	SE1	6000	35	0.110	300	2400	3000	3.0	-40	70	100	70
35.5×35.5×10	SE2	8400	35	0.060	350	2800	3500	1.5	-40	70	100	85
35.5×35.5×12	SE3	11000	40	0.060	400	3200	4000	1.4	-45	70	100	95
35.5×35.5×16	SE4	16000	40	0.035	500	4000	5000	1.4	-45	70	100	125
35.5×35.5×18	SE5	20000	40	0.035	500	4000	5000	1.4	-45	70	100	148
35.5×35.5×20	SE6	20000	40	0.035	500	4000	5000	1.4	-45	70	100	150
35.5×35.5×24	SE7	24000	40	0.035	600	4800	6000	1.4	-45	70	100	190

**CAPACITANCE AND RATED VOLTAGE RANGE**

Size	Size Code	Rated Cap (μF)	Maximum Value									Product Weight* (g)
			Tgδ(%)	ESR(Ω) 1kHz	Max DCL(μA)			Max Impedance (Ω) at -55°C 100Hz	Max Cap Deviation(%)			
					25°C	85°C	125°C		-55°C	85°C	125°C	
Rated voltage@85°C:80V Category Voltage@125°C:48V Surge Voltage:88V												
φ12×8	CA1	400	25	1.600	25	200	250	20.0	-35	70	75	8
φ12×10	CA2	480	25	1.600	30	240	300	17.0	-35	70	75	9
φ12×12	CA3	800	25	1.000	50	400	500	12.0	-35	70	75	11
φ16×8	CB1	500	25	0.350	30	240	300	10.0	-35	70	75	12
φ16×10	CB2	700	25	0.290	45	360	450	10.0	-35	70	75	15
φ16×12	CB3	1000	25	0.250	64	512	640	8.0	-35	70	75	18
φ16×16	CB4	1500	25	0.150	96	768	960	6.2	-35	70	75	25
φ22×8	CD1	860	30	0.400	65	520	650	12.0	-35	70	75	25
φ22×8	CD1	1100	30	0.400	70	560	700	12.0	-45	70	70	25
φ22×10	CD2	1500	30	0.300	96	768	960	8.0	-50	70	70	30
φ22×12	CD3	2200	30	0.200	140	1120	1400	8.0	-45	70	70	35
φ22×16	CD4	3300	30	0.200	210	1680	2100	8.0	-45	70	70	50
φ22×18	CD5	4000	30	0.200	250	2000	2500	8.0	-50	70	70	55
φ22×20	CD6	4400	30	0.150	280	2240	2800	6.0	-35	70	70	65
φ35,5×8	CE1	2800	40	0.100	150	1200	1500	1.6	-35	50	65	55
φ35,5×10	CE2	3600	40	0.100	200	1600	2000	1.6	-40	50	65	72
φ35,5×12	CE3	5600	40	0.060	300	2400	3000	1.6	-40	50	65	85
φ35,5×16	CE4	8200	40	0.060	450	3600	4500	1.6	-40	50	65	110
φ35,5×18	CE5	11000	45	0.060	500	4000	5000	1.6	-50	50	65	120
φ35,5×20	CE6	11000	45	0.035	500	4000	5000	1.6	-50	50	65	140
φ35,5×24	CE7	14000	45	0.035	800	6400	8000	1.6	-50	50	65	165
φ35,5×8	FE1	2800	40	0.100	150	1200	1500	1.6	-35	50	65	68
φ35,5×10	FE2	3600	40	0.100	200	1600	2000	1.6	-40	50	65	85
φ35,5×12	FE3	5600	40	0.060	300	2400	3000	1.6	-40	50	65	95
φ35,5×16	FE4	8200	40	0.060	450	3600	4500	1.6	-40	50	65	115
φ35,5×18	FE5	11000	45	0.060	500	4000	5000	1.6	-50	50	65	135
φ35,5×20	FE6	11000	45	0.035	500	4000	5000	1.6	-50	50	65	160
φ35,5×24	FE7	14000	45	0.035	800	6400	8000	1.6	-50	50	65	180
20×20×8	SC1	1200	30	0.400	90	720	900	12.0	-40	70	70	25
20×20×10	SC2	1600	30	0.200	120	960	1200	8.0	-50	70	70	30
20×20×12	SC3	2400	30	0.200	180	1440	1800	8.0	-40	70	70	38
20×20×16	SC4	3600	30	0.200	270	2160	2700	8.0	-40	70	70	48
20×20×18	SC5	4200	30	0.200	350	2800	3500	8.0	-50	70	70	52
20×20×20	SC6	4800	30	0.080	350	2800	3500	6.0	-40	70	70	58
35,5×35,5×8	SE1	3500	30	0.100	200	1600	2000	1.6	-35	70	70	70
35,5×35,5×10	SE2	4500	30	0.080	300	2400	3000	1.4	-40	70	70	88
35,5×35,5×12	SE3	6800	30	0.060	450	3600	4500	1.6	-40	70	70	95
35,5×35,5×16	SE4	10000	30	0.040	500	4000	5000	1.6	-40	70	70	125
35,5×35,5×18	SE5	12000	30	0.040	500	4000	5000	1.6	-40	70	70	150
35,5×35,5×20	SE6	14000	25	0.050	700	5600	7000	1.6	-25	45	50	155
35,5×35,5×24	SE7	16000	35	0.050	700	5600	7000	1.6	-25	45	50	190

**CAPACITANCE AND RATED VOLTAGE RANGE**

Size	Size Code	Rated Cap (μF)	Maximum Value									Product Weight* (g)
			Tgδ(%)	ESR(Ω) 1kHz	Max DCL(μA)			Max Impedance (Ω) at -55°C 100Hz	Max Cap Deviation(%)			
					25°C	85°C	125°C		-55°C	85°C	125°C	
<b>Rated voltage@85°C:100V Category Voltage@125°C:60V Surge Voltage:110V</b>												
φ12×8	CA1	100	25	2.200	24	192	240	24.0	-25	65	70	8
φ12×10	CA2	130	25	2.200	30	240	300	20.0	-25	65	70	9
φ12×12	CA3	200	25	1.200	50	400	500	12.0	-25	65	70	11
φ16×8	CB1	180	25	0.900	15	120	150	18.0	-25	65	70	12
φ16×10	CB2	250	25	0.900	20	160	200	18.0	-25	65	70	15
φ16×12	CB3	360	25	0.350	30	240	300	16.0	-25	65	70	18
φ16×16	CB4	540	25	0.350	45	360	450	14.0	-25	65	70	25
φ22×8	CD1	400	25	0.500	30	240	300	14.0	-35	65	70	25
φ22×10	CD2	540	25	0.300	45	360	450	8.0	-35	65	70	30
φ22×12	CD3	800	25	0.200	65	520	650	10.0	-35	65	70	36
φ22×16	CD4	1200	25	0.200	100	800	1000	8.0	-35	65	70	50
φ22×18	CD5	1500	25	0.200	200	1600	2000	8.0	-35	65	70	55
φ22×20	CD6	1600	25	0.150	200	1600	2000	6.0	-35	65	70	65
φ35.5×8	CE1	1200	35	0.250	150	1200	1500	4.0	-40	65	70	55
φ35.5×10	CE2	1600	35	0.130	200	1600	2000	3.0	-40	65	70	72
φ35.5×12	CE3	2400	35	0.100	200	1600	2000	1.8	-35	65	70	85
φ35.5×16	CE4	3600	35	0.075	200	1600	2000	1.8	-35	65	70	110
φ35.5×18	CE5	4200	40	0.075	200	1600	2000	1.8	-55	65	70	130
φ35.5×20	CE6	4800	40	0.065	200	1600	2000	1.8	-35	65	70	150
φ35.5×24	CE7	6000	40	0.065	200	1600	2000	1.8	-35	65	70	165
φ35.5×24	CE7	10000	40	0.040	800	6400	8000	1.0	-55	65	70	175
φ35.5×8	FE1	1200	35	0.250	150	1200	1500	4.0	-40	65	70	70
φ35.5×10	FE2	1600	35	0.130	200	1600	2000	3.0	-40	65	70	85
φ35.5×12	FE3	2400	35	0.100	200	1600	2000	1.8	-35	65	70	95
φ35.5×16	FE4	3600	35	0.075	200	1600	2000	1.8	-35	65	70	125
φ35.5×18	FE5	4200	40	0.075	200	1600	2000	1.8	-55	65	70	140
φ35.5×20	FE6	4800	40	0.065	200	1600	2000	1.8	-35	65	70	160
φ35.5×24	FE7	6000	40	0.065	200	1600	2000	1.8	-35	65	70	180
20×20×8	SC1	420	25	0.600	65	520	650	14.0	-35	65	70	26
20×20×10	SC2	550	25	0.300	85	680	850	8.0	-35	65	70	32
20×20×12	SC3	840	25	0.300	200	1600	2000	10.0	-35	65	70	40
20×20×16	SC4	1260	25	0.200	300	2400	3000	8.0	-35	65	70	50
20×20×18	SC5	1500	25	0.200	400	3200	4000	8.0	-35	65	70	56
20×20×20	SC6	1680	25	0.150	400	3200	4000	6.0	-35	65	70	62
35.5×35.5×8	SE1	2200	25	0.150	300	2400	3000	4.0	-35	65	70	75
35.5×35.5×10	SE2	3000	25	0.100	400	3200	4000	2.0	-35	65	70	88
35.5×35.5×12	SE3	4500	25	0.080	500	4000	5000	1.8	-35	65	70	100
35.5×35.5×16	SE4	7000	40	0.050	500	4000	5000	1.8	-35	65	70	130
35.5×35.5×18	SE5	8000	40	0.050	500	4000	5000	1.8	-35	65	70	165
35.5×35.5×20	SE6	9000	25	0.050	700	4200	7000	1.8	-25	80	70	165
35.5×35.5×24	SE7	10000	40	0.050	800	6400	8000	2.0	-35	65	70	200



**CAPACITANCE AND RATED VOLTAGE RANGE**

Size	Size Code	Rated Cap (μF)	Maximum Value									Product Weight* (g)
			Tgδ(%)	ESR(Ω) 1kHz	Max DCL(μA)			Max Impedance (Ω) at -55°C 100Hz	Max Cap Deviation(%)			
					25°C	85°C	125°C		-55°C	85°C	125°C	
Rated voltage@85°C:125V Category Voltage@125°C:75V Surge Voltage:137.5V												
φ16×8	CB1	100	20	1.500	10	80	100	30.0	-20	45	50	12
φ16×10	CB2	150	20	1.500	20	160	200	18.0	-20	45	50	15
φ16×12	CB3	200	20	0.400	20	160	200	18.0	-20	45	50	18
φ16×16	CB4	300	20	0.400	45	360	450	16.0	-20	45	50	25
φ22×8	CD1	300	25	0.600	30	240	300	20.0	-20	45	50	25
φ22×10	CD2	400	25	0.400	45	360	450	12.0	-20	45	50	30
φ22×12	CD3	600	25	0.240	45	360	450	10.0	-20	45	50	38
φ22×16	CD4	900	25	0.250	90	720	900	10.0	-20	45	50	50
φ22×18	CD5	1100	25	0.250	150	1200	1500	10.0	-20	45	50	55
φ22×20	CD6	1200	25	0.200	200	1600	2000	8.0	-20	45	50	65
φ35.5×8	CE1	1100	35	0.200	150	1200	1500	8.0	-45	35	40	58
φ35.5×10	CE2	1500	35	0.200	150	1200	1500	8.0	-45	35	40	72
φ35.5×12	CE3	2200	35	0.180	300	2400	3000	2.5	-45	35	40	85
φ35.5×16	CE4	3300	30	0.100	450	3600	4500	2.5	-45	35	40	115
φ35.5×18	CE5	3300	35	0.075	500	4000	5000	2.5	-40	35	40	130
φ35.5×18	CE5	4500	35	0.075	500	4000	5000	2.5	-45	35	40	130
φ35.5×20	CE6	4500	35	0.050	500	4000	5000	2.5	-45	35	40	158
φ35.5×24	CE7	5500	35	0.050	550	4400	5500	2.5	-50	35	40	180
φ35.5×8	FE1	1100	35	0.200	150	1200	1500	8.0	-45	35	40	70
φ35.5×10	FE2	1500	35	0.200	150	1200	1500	8.0	-45	35	40	85
φ35.5×12	FE3	2200	35	0.180	300	2400	3000	8.0	-45	35	40	100
φ35.5×16	FE4	3300	30	0.100	450	3600	4500	2.5	-45	35	40	130
φ35.5×18	FE5	4500	35	0.050	500	4000	5000	2.5	-45	35	40	145
φ35.5×20	FE6	5000	35	0.050	500	4000	5000	2.5	-45	35	40	170
φ35.5×24	FE7	5500	35	0.050	550	4400	5500	2.5	-50	35	40	180
20×20×8	SC1	320	25	0.800	50	400	500	20.0	-20	45	50	28
20×20×10	SC2	420	25	0.400	65	520	650	12.0	-20	45	50	34
20×20×12	SC3	640	25	0.400	150	1200	1500	10.0	-20	45	50	40
20×20×16	SC4	960	25	0.270	200	1600	2000	10.0	-20	45	50	52
20×20×18	SC5	1100	25	0.270	300	2400	3000	10.0	-20	45	50	60
20×20×20	SC6	1280	25	0.200	350	2800	3500	8.0	-20	45	50	66
35.5×35.5×8	SE1	1400	25	0.200	250	2000	2500	8.0	-25	45	50	80
35.5×35.5×10	SE2	1800	25	0.120	300	2400	3000	2.4	-25	45	50	95
35.5×35.5×12	SE3	2800	25	0.100	450	3600	4500	2.4	-25	45	50	110
35.5×35.5×16	SE4	4200	25	0.065	500	4000	5000	2.4	-25	45	50	140
35.5×35.5×18	SE5	4800	25	0.065	500	4000	5000	2.4	-25	45	50	165
35.5×35.5×20	SE6	5600	25	0.050	700	5600	7000	2.4	-25	45	50	165
35.5×35.5×24	SE7	7000	35	0.050	700	5600	7000	2.4	-25	45	50	200

**CAPACITANCE AND RATED VOLTAGE RANGE**

Size	Size Code	Rated Cap (μF)	Maximum Value									Product Weight* (g)
			Tgδ(%)	ESR(Ω) 1kHz	Max DCL(μA)			Max Impedance (Ω) at -55°C 100Hz	Max Cap Deviation(%)			
					25°C	85°C	125°C		-55°C	85°C	125°C	
Rated voltage@85°C:150V Category Voltage@125°C:90V Surge Voltage:165V												
φ 16 × 8	CB1	100	20	1.500	15	120	150	36.0	-40	35	50	12
φ 16 × 10	CB2	140	20	1.500	22	176	220	20.0	-40	35	50	15
φ 16 × 12	CB3	200	20	1.000	30	240	300	20.0	-40	35	50	18
φ 16 × 16	CB4	300	20	0.800	45	360	450	26.0	-40	35	50	25
φ 22 × 8	CD1	200	25	1.200	30	240	300	25.0	-40	35	50	25
φ 22 × 10	CD2	280	25	0.600	42	336	420	20.0	-40	35	50	35
φ 22 × 12	CD3	400	25	0.360	60	480	600	26.0	-40	35	50	40
φ 22 × 12	CD3	470	15	0.360	50	400	500	26.0	-40	15	25	40
φ 22 × 16	CD4	600	25	0.300	90	720	900	15.0	-40	35	50	55
φ 22 × 18	CD5	700	25	0.500	105	840	1050	15.0	-40	35	50	58
φ 22 × 20	CD6	800	25	0.200	120	960	1200	12.0	-40	35	50	70
φ 35,5 × 8	CE1	680	20	0.300	102	816	1020	10.0	-40	35	40	60
φ 35,5 × 10	CE2	820	20	0.200	123	984	1230	6.0	-40	35	40	72
φ 35,5 × 12	CE3	1200	20	0.200	180	1440	1800	5.0	-40	35	40	90
φ 35,5 × 16	CE4	1800	20	0.120	270	2160	2700	5.0	-40	35	40	120
φ 35,5 × 18	CE5	2000	20	0.200	300	2400	3000	5.0	-40	35	40	135
φ 35,5 × 20	CE6	2400	20	0.090	360	2880	3600	5.0	-40	35	40	160
φ 35,5 × 24	CE7	3000	20	0.085	450	3600	4500	5.0	-40	35	40	180
φ 35,5 × 8	FE1	680	20	0.300	102	816	1020	10.0	-40	35	40	73
φ 35,5 × 10	FE2	820	20	0.200	123	984	1230	6.0	-40	35	40	90
φ 35,5 × 12	FE3	1200	20	0.200	180	1440	1800	5.0	-40	35	40	105
φ 35,5 × 16	FE4	1800	20	0.120	270	2160	2700	5.0	-40	35	40	135
φ 35,5 × 18	FE5	2000	20	0.200	300	2400	3000	5.0	-40	35	40	152
φ 35,5 × 20	FE6	2400	20	0.090	360	2880	3600	5.0	-40	35	40	180
φ 35,5 × 24	FE7	3000	20	0.085	450	3600	4500	5.0	-40	35	40	200
20 × 20 × 8	SC1	210	25	1.200	40	320	400	25.0	-40	45	50	30
20 × 20 × 10	SC2	280	25	0.800	42	336	420	20.0	-40	45	50	35
20 × 20 × 12	SC3	420	25	0.600	63	504	630	26.0	-40	45	50	45
20 × 20 × 16	SC4	630	25	0.400	120	960	1200	15.0	-40	45	50	55
20 × 20 × 18	SC5	760	25	0.400	120	960	1200	15.0	-40	45	50	62
20 × 20 × 20	SC6	840	25	0.300	126	1008	1260	12.0	-40	45	50	70
35,5 × 35,5 × 8	SE1	800	25	0.300	120	960	1200	10.0	-40	45	50	85
35,5 × 35,5 × 10	SE2	900	25	0.180	135	1080	1350	5.0	-40	45	50	95
35,5 × 35,5 × 12	SE3	1600	25	0.150	240	1920	2400	5.0	-40	45	50	120
35,5 × 35,5 × 16	SE4	2400	25	0.120	360	2880	3600	5.0	-40	45	50	150
35,5 × 35,5 × 18	SE5	3000	25	0.120	360	2880	3600	5.0	-40	45	50	180
35,5 × 35,5 × 20	SE6	3200	25	0.100	480	3840	4800	5.0	-40	45	50	200
35,5 × 35,5 × 24	SE7	4000	35	0.075	600	4800	6000	5.0	-40	45	50	220

**MEASUREMENT CONDITIONS**

- a) Capacitance and DF are measured at 100Hz, 1V RMS with DC bias of 2.2V.
- b) Leakage Current is measured at rated voltage after 5 minutes.
- c) ESR is measured at 1kHz, 0.5V RMS with DC bias of 2.2V.